

step 2

## 900mm drawer dividers

suits timber drawers

1 set | W-50339 | 

- easy click lock system
- durable aluminium rails
- suitable for use with Kaboodle Kitchens

step 2

## 900mm drawer dividers

suits timber drawers

1 set | W-50339 | 

step 2

step 1	✓ step 2	✓ step 3	step 4
You've got your cabinets ...	You've grabbed the parts you need - things like hinges, drawer runners and accessories.	Next you'll need to collect your cabinet doors, drawer fronts, panels and kickboards.	Finally, you'll need to grab your benchtops and enjoy bringing your Kaboodle Kitchen to life!

 kaboodle®  
KITCHEN

 kaboodle®  
KITCHEN



9 320090 503399

made in China

hardware key

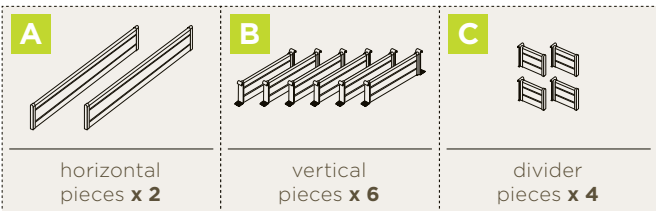

## assembling the drawer dividers

900mm **drawer dividers**  
suits timber drawers

### attaching the divider pieces to the horizontal pieces

1.

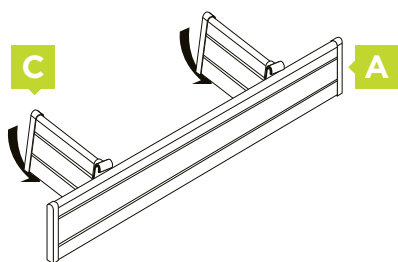

### attach the vertical pieces to the horizontal pieces

2.

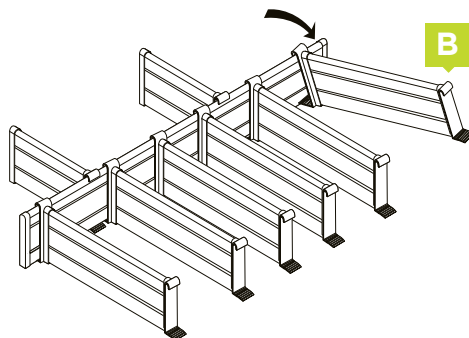

### attaching the horizontal piece to the vertical pieces

3.

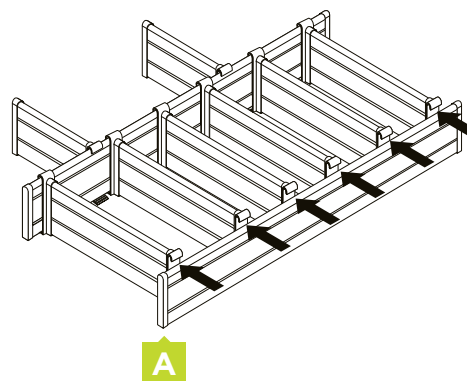

### insert the drawer dividers into the timber drawer

4.

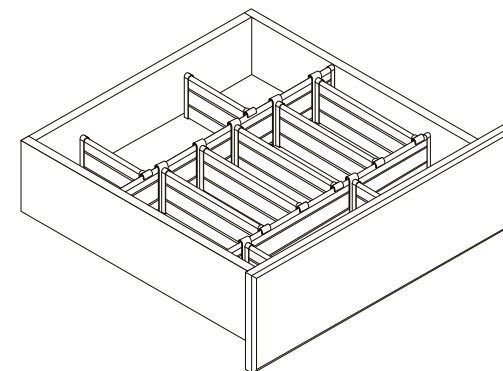

#### Caring for your Kaboodle parts and accessories

Looking after your parts and accessories is really easy and with the right care and maintenance they will last you for many years. Just follow these simple steps.

Hinges, runners and other parts and accessories should be kept dry at all times. To keep the mechanisms performing at their best, regularly wipe them with a dry cloth removing any dust and grime that may build up. In case of spills, clean immediately with a dry cloth. Do not use harsh abrasives.

If you need any more information you can contact us:  
Australia: **1800 666 078** Monday to Friday between 8:00am and 6:00pm AEST.  
New Zealand: **0800 522 663** Monday to Friday between 8:00am and 5:00pm NZST  
or email: [info@kaboodlegroup.com.au](mailto:info@kaboodlegroup.com.au).

step 1	✓ step 2	✓ step 3	step 4
Your cabinets are now assembled.	You've finished adding your parts and accessories.	Next, follow the instructions to fit your doors and panels.	Finish off your Kaboodle Kitchen by installing your benchtop.